

SOFA

Liberti
COMPOSITION SOFA



Technical Features

Design Massimiliano Raggi

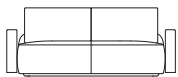

L: 220 cm - L: 86 ⁵/₈"

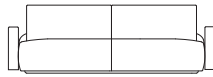
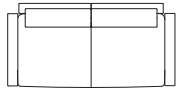

L: 266 cm - L: 104 ³/₄"

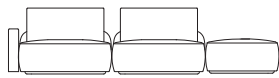
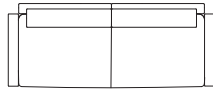

L: 350 cm - L: 137 ³/₄"

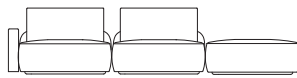
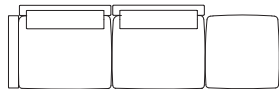

L: 375 cm - L: 147 ⁵/₈"

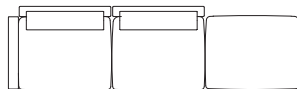

L: 312 cm - L: 122 ⁷/₈"

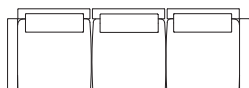

L: 387 cm - L: 152 ³/₈"

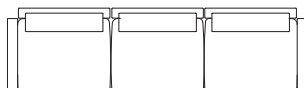

L: 387 cm X D: 153 cm - L: 152 ³/₈" x D: 60 ¹/₄"

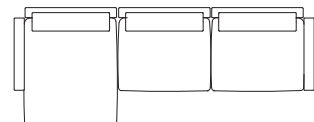

SOFA

Liberti

SIDE UNIT 133 LEFT OR RIGHT



Sofa , frame made of solid timber and plywood. Polyurethane foam padding. Solid timber armrest, moka finish.

Technical Features

Design RADS

W:133 cm x D:108 cm x H:85 cm

W:52 ^{3/8"} x D:43 ^{1/4"} x H:33 ^{1/2"}

Weight: 35 kg

COM: 6 ml - COL: 10 sqm

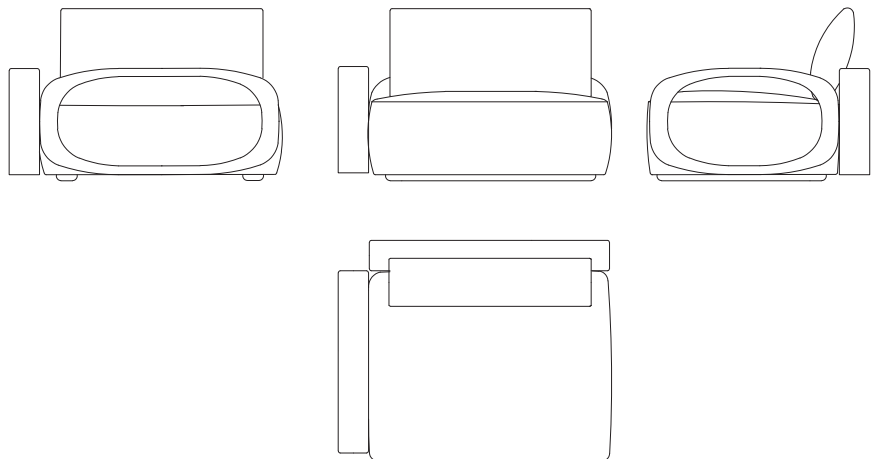

SOFA

Liberti

CHAISE UNIT LEFT OR RIGHT



Sofa , frame made of solid timber and plywood. Polyurethane foam padding. Solid timber armrest, moka finish.

Technical Features

Design RADS

W:133 cm x D:153 cm x H:85 cm

W:47 ¹/₄" x D:60 ¹/₄" x H:34 ⁵/₈"

Weight: 50 kg

COM: 9 ml - COL: 13 sqm

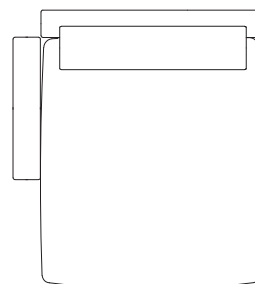
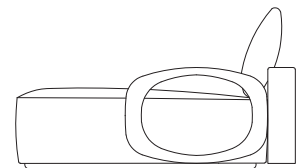
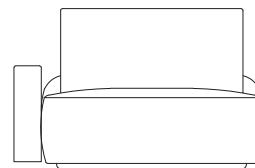
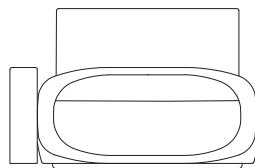

SOFA

Liberti

MIDDLE UNIT 120



Sofa , frame made of solid timber and plywood. Polyurethane foam padding. Solid timber armrest, moka finish.

Technical Features

Design RADS

W:120 cm x D:108 cm x H:85 cm

W:47 1/4" x D:43 1/4" x H:33 1/2"

Weight: 25 kg

COM: 6 ml - COL: 9 sqm

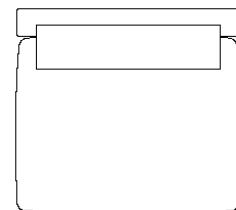
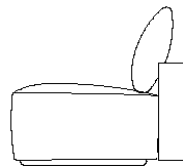
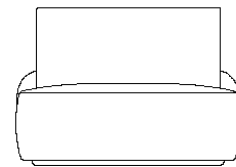
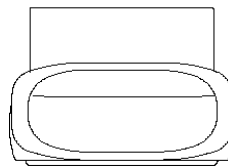

SOFA

Liberti

MIDDLE UNIT 95



Sofa , frame made of solid timber and plywood. Polyurethane foam padding. Solid timber armrest, moka finish.

Technical Features

Design RADS

W:95 cm x D:108 cm x H:45 cm

W:37^{3/8"} x D:43^{1/4"} x H:21^{5/8"}

Weight: 10 kg

COM: 5 ml - COL: 7 sqm

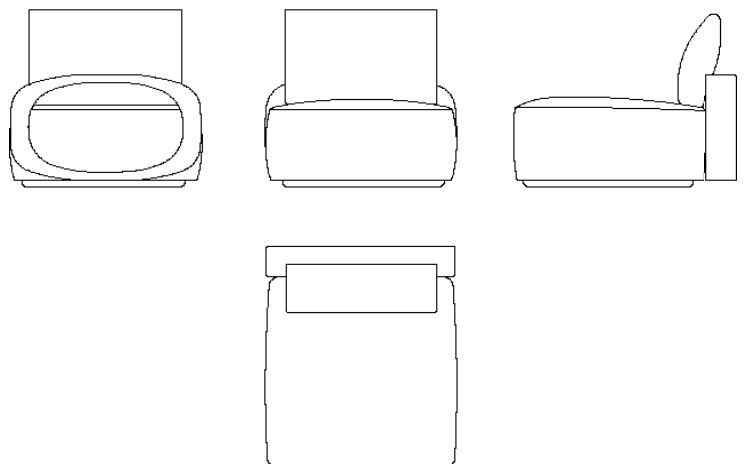

SOFA

Liberti

2 SEATER



Sofa , frame made of solid timber and plywood. Polyurethane foam padding. Solid timber armrest, moka finish.

Technical Features

Design RADS

W:216 cm x D:108 cm x H:85 cm

W:86 ⁵/₈" x D:43 ¹/₄" x H:33 ¹/₂"

Weight: 50 kg

COM: 8 ml - COL: 12 sqm

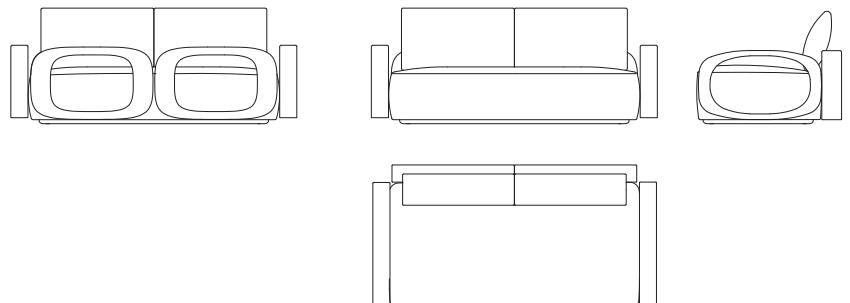

SOFA

Liberti

3 SEATER



Sofa , frame made of solid timber and plywood. Polyurethane foam padding. Solid timber armrest, moka finish.

Technical Features

Design RADS

W: 266 cm x D: 108 cm x H: 85 cm

W: 104^{3/4"} x D: 42^{1/2"} x H: 33^{1/2"}

Weight: 60 kg

COM: 11 ml - COL: 16 sqm

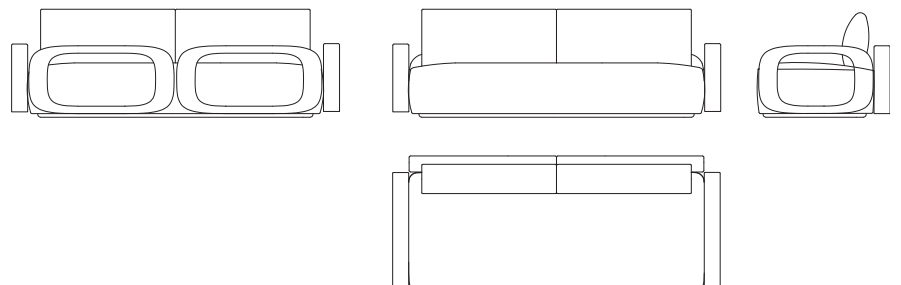

SOFA

Liberti

POUF 95



Sofa , frame made of solid timber and plywood. Polyurethane foam padding. Solid timber armrest, moka finish.

Technical Features

Design RADS

W:95 cm x D:95 cm x H:45 cm

W:37 ^{3/8}" x D:43 ^{1/4}" x H:21 ^{5/8}"

Weight: 10 kg

COM: 5 ml - COL: 7 sqm

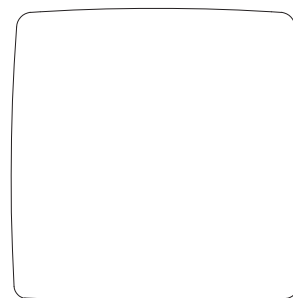
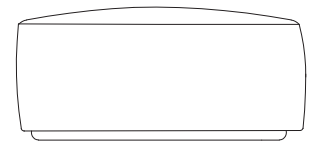
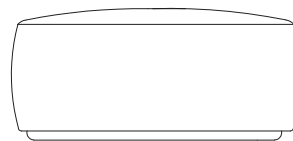

SOFA

Liberti

POUF 120



Sofa , frame made of solid timber and plywood. Polyurethane foam padding. Solid timber armrest, moka finish.

Technical Features

Design RADS

W:120 cm x D:95 cm x H:45 cm

W:47 1/4" x D:43 1/4" x H:21 5/8"

Weight: 10 kg

COM: 5 ml - COL: 7 sqm

